

Chaflanadoras - Biseladoras / Beveling machines - Bevellers



Experts in Plate Beveling (Unique & Authentic)
WE ARE MANUFACTURERS

cevvisa[®]
beveling machines

ACAT

TEL. 81 8354 8910
www.acatmexicana.com

▶ **CHP 30G**

• Chaflán en X
• X Bevel

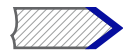

• Chaflán en K
• K Bevel



• Chaflán en V
• V Bevel



• Chaflán en Y
• Y Bevel

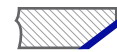

• Chaflán de transición
• Slop

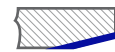

• Chaflán de transición
• Slop + Bevel



CHP 30G



VENTAJAS

- Silenciosa y sin vibraciones. Acabado impecable.
- Robusta y fácil de manejar.
- Trabaja con cualquier material manteniendo las prestaciones.
- RPM y avance regulables.

ADVANTAGES

- Silent and without vibrations. Perfect finishing.
- Reliable and easy to use.
- Any material can be beveled with the same capacity.
- RPM and feeding adjustable.



TABLA DE CHAFLANADO / BEVELLING TABLE

MÚLTIPLES PASADAS / MULTIPLE RUNS				UNA SOLA PASADA / SINGLE RUN				
α	w	d	α	w	d	α	w	d
15°	35	34	45°	35	25	15°	26	25
20°	35	33	50°	35	22	20°	22	21
25°	35	32	55°	35	20	25°	20	18
30°	35	30	60°	35	17	30°	18	16
35°	35	29	65°	35	15	35°	17	14
40°	35	27	70°	35	12	40°	17	13
						45°	15	11
						50°	15	10
						55°	17	10
						60°	18	9
						65°	21	9
						70°	26	9

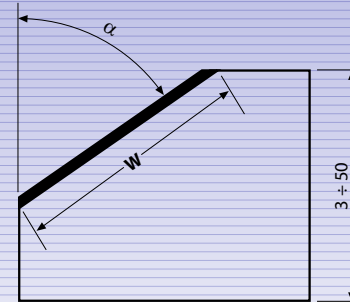

Es La CHP-30G es realmente una fresadora portátil por sus prestaciones y acabado. Ideal para chaflanes con longitudes de hasta 35 mm.

En The CHP-30G is really a portable milling machine taking into account their capacity and finishing. Unique solution on the market.

CEVISA[®]
beveling machines

CHP-30G

MAX	MAX	Esesor Máximo Recomendado Max. Recommended Thickness	Esesor Máximo Nominal * Max. Nominal Thickness *	m/min	Ángulo Chaflanado * Beveling Angle *	Potencia Motor Motor Power	Peso Máquina Machine Net Weight
25 mm	35 mm	50 mm	50 mm	800 mm/min	15° ÷ 70°	3 H.P.	620 kg

* Otras configuraciones disponibles bajo pedido / Other configurations available under request

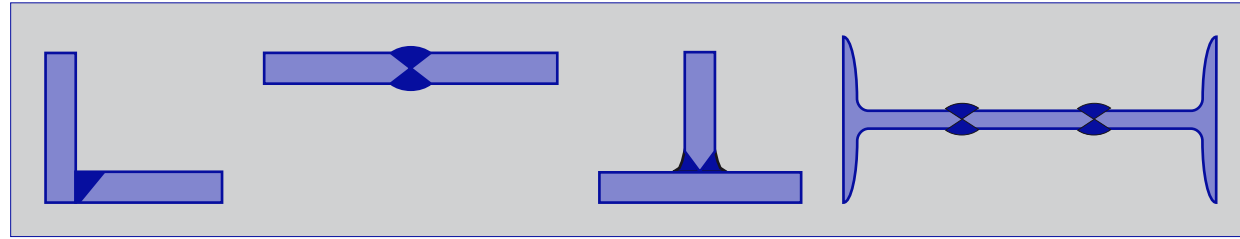
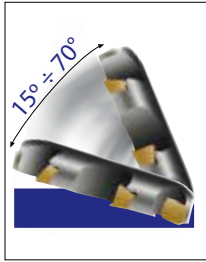

CHP 30G



Caja eléctrica - neumática.
Electric - pneumatic box.



Sist. neumático para ajustar altura de trabajo (OPCIONAL).
Pneumatic system to adjust working height (OPTIONAL).



Display electrónico penetración herramienta.
Electronic display to control cutter penetration.



Sistema neumático para fijar el material.
Pneumatic system to fix the plate.



Panel de control completo.
Complete control panel.

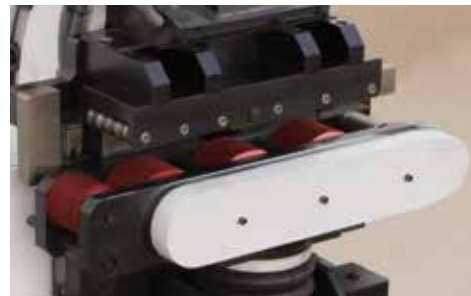

Sistema de tracción.
Feeding system



365 - 24 máquina.
365 - 24 machine.



Reductor sistema de tracción.
Feeding system gear reducer



Sales partner in Mexico:



ACAT MEXICANA

Ave. Regio Parque #200 Regio Parque Industrial
Apodaca, Nuevo León, México CP. 66633



acat@acatmexicana.com



TEL. 81 8354 8910



www.acatmexicana.com